

# URS SERIES

June 2004

[www.DanaherMotion.com](http://www.DanaherMotion.com)



## COMPACT BALLSCREW POSITIONING TABLES

The IDC URS-series with integrated stell real provides superior product performance in a compace package.



 Solutions by  
**DANAHER**  
MOTION

Sold & Serviced By:

 **ELECTROMATE**

Toll Free Phone (877) SERV098

Toll Free Fax (877) SERV099

[www.electromate.com](http://www.electromate.com)

[sales@electromate.com](mailto:sales@electromate.com)

## Welcome to Danaher Motion - IDC

While business cycles will ebb and flow, technological advancements across a multitude of industries march forward. In many cases, the success of these advancements hinges upon the ability of engineers to create automated systems capable of accurately manipulating materials at both the macro and microscopic levels. Danaher Motion solutions are often at the core of these systems. Many recent advancements in the semiconductor, flat panel display, data storage, digital imaging, transportation, machine automation, and life sciences markets have been made possible by actuators and positioning systems designed and manufactured by Danaher Motion.

IDC offers an expansive range of mechanical and control products for automated positioning applications. Our customers turn to us for complete solutions to their automation needs. Our products are found in a wide variety of industrial, scientific, and commercial applications. Virtually anywhere that thrust, torque, speed, or position must be controlled, IDC has the solution. Our electro-mechanical product offering is highlighted by our standard product range of Electric Cylinders, Rodless Actuators, and Precision Positioning Tables.

**Electric Cylinders** are essentially thrust producing devices that are best suited for applications requiring high axial force with the moment and side loads already properly supported.

Screw driven **Rodless Actuators** are also thrust producing devices that are best for axial force applications where the space is limited and a payload must also be supported or carried. As individual components, Rodless Actuators are not well suited for moment loading; however, they can be effectively combined into complete Cartesian Systems for some multi-axis applications. For higher speed, lower thrust applications, Rodless Actuators can be repeatably driven with a timing belt instead of a screw.

**Precision Positioning Tables** are best suited for applications where the accuracy and repeatability requirements are more important than axial thrust of the drive train. Precision Positioning Tables can also be used in less precise applications where adequate moment load support is necessary. Precision Positioning Tables are ideal building blocks for complete multi-axis positioning systems.

Our IDC product brand contains hundreds of standard electromechanical solutions. Still, we recognize that each application is unique and so we continue to welcome opportunities that require modification and occasionally complete redesign of our standard solutions.

Contact Danaher Motion today to discuss how we can put our trusted brand names, extensive product portfolio, and extensive applications expertise to work to provide you with your total motion control solution.

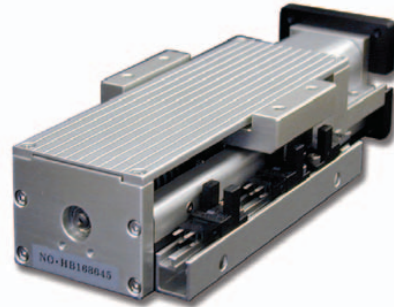

URS 3305A-150-X2345 Positioning Table

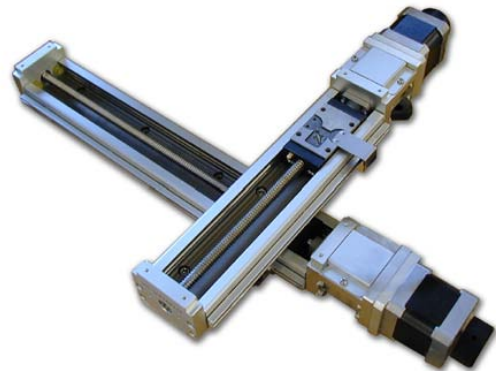

XY featuring URS20 Positioning Tables. Consult factory for multi-axis configurations.

Solutions by  
**DANAHER**  
 MOTION

Sold & Serviced By:

 **ELECTROMATE**

Toll Free Phone (877) SERV098

Toll Free Fax (877) SERV099

[www.electromate.com](http://www.electromate.com)

[sales@electromate.com](mailto:sales@electromate.com)

## TABLE OF CONTENTS:

Welcome to Danaher Motion – IDC .....	Inside Front Cover
Table of Contents .....	1
URS Overview .....	2
Specifications	
URS20 .....	4
URS26 .....	4
URS33 .....	4
URS46 .....	5
URS55 .....	5
Dimensional Drawings	
URS20 .....	6
URS26 .....	8
URS33 .....	10
URS46 .....	14
URS55 .....	18
Motor Options	
Flanges for Customer Mounted Motors .....	20
Stepper Motors .....	22
Servo Motors <sup>24</sup>	
Cleanroom Lubrication Option .....	25
Raydent Surface Treatment Option .....	25
Limit Switch Options .....	26
Inertia of the Carriage(s) and Ballscrews .....	28
Accuracy Standards .....	29
Rated Life Calculations .....	30
Part Numbering/Ordering Information .....	32
Configuration Guide .....	Inside Back Cover
Lubrication and Operation Notes .....	Inside Back Cover

## URS = U RAIL SYSTEM.

The URS is a compact single-axis positioning table which integrates a linear bearing and precision ballscrew.

The URS series offers compact dimensions and outperforms conventional positioning tables. This is made possible by a unique "U" shaped guide rail and recirculating bearing module which provides the dual functions of a guide block and a ball screw nut. The "U" shaped guide rail design offers a highly rigid structure resistant to bending, allowing the URS to be single-end supported. Additionally, the bearing module contains four ball circuits which deliver high load capacity, high accuracy and high rigidity.

- COMPACT SIZE
- OPTIMIZED DESIGN
- RIGIDITY
- VALUE

### Packaged Solution:

The integration of the slide guide and precision ballscrew eliminates complex precision adjustment and reduces installation time dramatically as compared to purchasing and assembling individual components.

### High Rigidity:

"U" shaped steel guide rail provides very high rigidity despite its compact profile, and excels in one-end supported (cantilevered slide) applications.

### High Accuracy:

The URS shuttle carriage contains four ball circuits and four-point contact ball grooves, which contributes to its high rigidity. The combination of precision ground guide rail, carriage, and precision grade ball screw provides high positioning accuracy.

### Space Saving:

In comparison to conventional positioning tables, the compact design of the URS allows for dramatic space savings. The "U" shaped guide rail and integrated carriage/ballnut design make this possible.

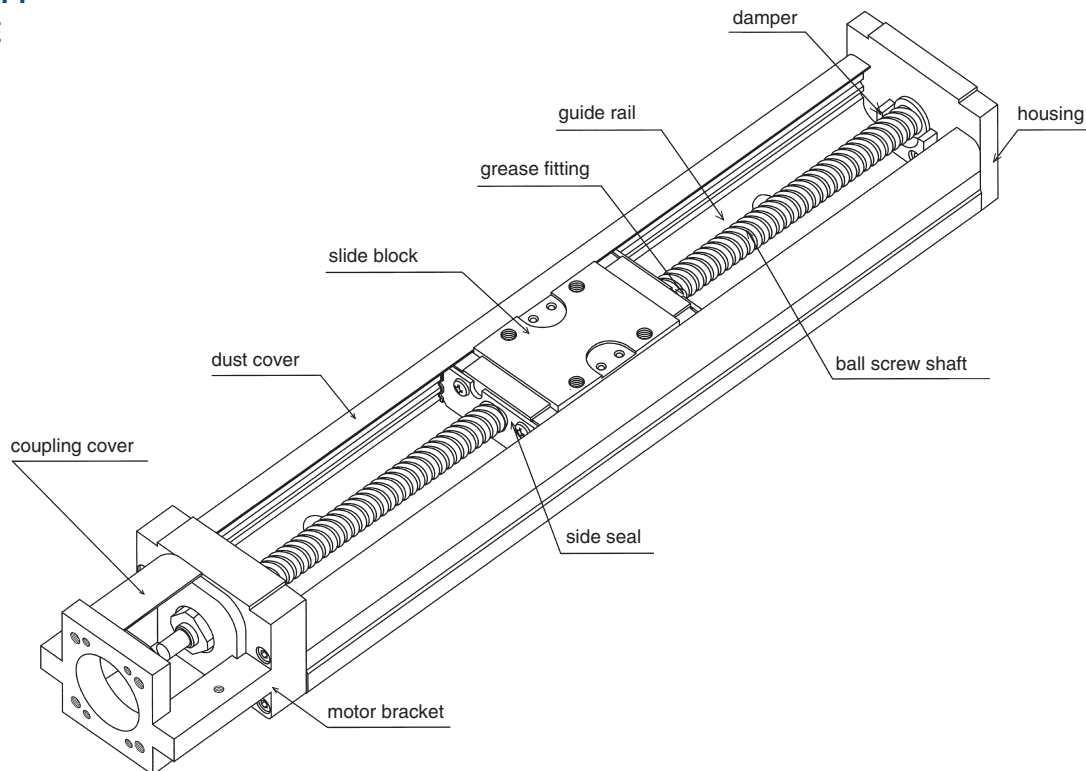

## URS-SERIES OVERVIEW

The IDC URS-Series Positioning Tables provide superior product performance in a compact size envelope.

- A precision ground steel base/rail provides exceptional rigidity and accuracy.

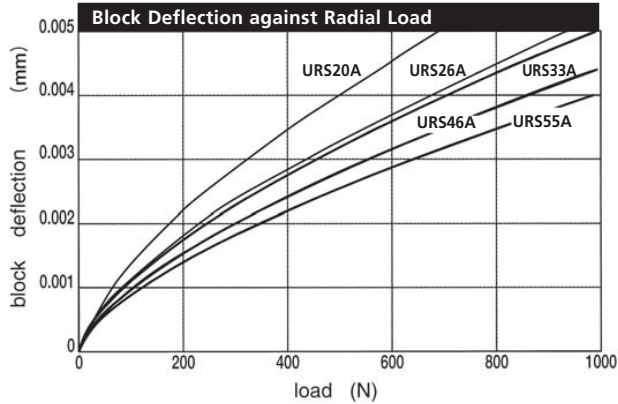

- The integrated linear bearing and precision ballscrew minimize the cross-sectional profile of the URS (see drawings below).
- The four-row linear bearing structure maximizes the rigidity of the carriage, and allows the URS to be mounted in any orientation.

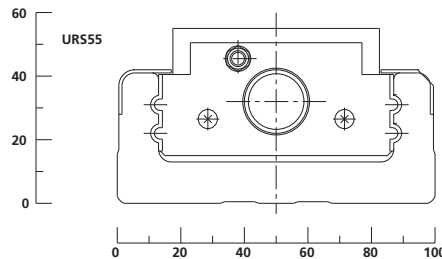
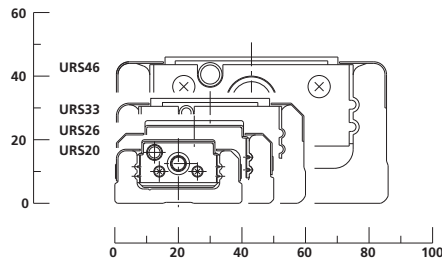
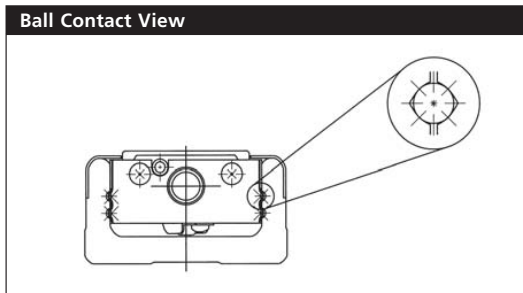

## SELECTABLE OPTIONS & ACCESSORIES

- Travel lengths from x to x cover a wide range of applications.
- Standard- and short-version carriages, and single- and dual-carriage options increase flexibility of load carrying.
- Commercial Grade with repeatability down to +/- 5 microns, and Precision Grade with repeatability down to +/- 3 microns.
- Motor flanges for NEMA 16, 17, 23 and 34 frame motors.
- Standard servo and stepper motor options.
- Hardcover is available to protect internal components and to contain lubrication within the URS.
- Limit switch packages with three (3) sensors adjustable throughout the range of travel.
- Cleanroom grease option for particulate-sensitive environments.
- Raydent surface treatment option for improved rust-resistance of the steel rail.

## SPECIFICATIONS

	URS20			URS26				URS33						
	100	150	200	150	200	250	300	150	200	300	400	500	600	
<b>RAIL LENGTH (mm)</b>														
<b>HEIGHT (base to carriage top)</b>														
without cover option (mm)	20			26				33						
without cover option [-H] (mm)	32			40				48						
<b>BASE WIDTH (mm)</b>	40			50				60						
<b>MAX TRAVEL (hardstop to hardstop)</b>														
single long carriage [A] (mm)	43	93	143	74	124	174	224	60	110	210	310	410	510	
dual long carriage [B] (mm)	-	50	100	-	60	110	160	-	-	133	233	333	433	
single short carriage [C] (mm)	-	-	-	-	-	-	-	85	135	235	335	435	535	
dual short carriage [D] (mm)	-	-	-	-	-	-	-	34	84	184	284	384	484	
<b>ACCURACY</b>														
commercial grade (microns)	50			50				30		35		40		70
precision grade [P] (microns)	20			20				15		20		25		-
<b>FLATNESS OF TRAVEL</b>														
commercial grade (microns)	25			25				25				35		
precision grade [P] (microns)	10			10				10				15		
<b>REPEATABILITY</b>														
commercial grade (microns)	±5			±5				±5						
precision grade [P] (microns)	±3			±3				±3						
<b>PITCH &amp; YAW</b>														
commercial grade (microns)	x	x	x	x	x	x	x	x	x	x	x	x	x	
precision grade [P] (microns)	x	x	x	x	x	x	x	x	x	x	x	x	x	
<b>LOAD CAPACITY, NORMAL (kg)</b>	x	x	x	x	x	x	x	x	x	x	x	x	x	
<b>AXIAL LOAD CAPACITY (kg)</b>	x	x	x	x	x	x	x	x	x	x	x	x	x	
<b>ACCELERATION, MAX (m/sec<sup>2</sup>)</b>	x	x	x	x	x	x	x	x	x	x	x	x	x	
<b>MOVING MASS</b>														
long carriage [A,B] w/o cover option (kg)	0.07			0.17				0.30						
long carriage [A,B] w/ cover option [-H] (kg)	0.11			0.24				0.40						
short carriage [C,D] w/o cover option (kg)	-			-				0.15						
short carriage [C,D] w/ cover option [-H] (kg)	-			-				0.20						
<b>TOTAL MASS</b>														
single long carriage [A] w/o cover option (kg)	0.42	0.58	0.71	0.93	1.14	1.36	1.57	1.6	2.0	2.6	3.2	3.9	4.6	
dual long carriage [B] w/o cover option (kg)	0.52	0.65	0.78	1.10	1.31	1.36	1.57	-	-	2.9	3.6	4.2	4.9	
single short carriage [C] w/o cover option (kg)	-	-	-	-	-	-	-	1.5	1.8	2.5	3.1	3.8	4.4	
dual short carriage [D] w/o cover option (kg)	-	-	-	-	-	-	-	1.7	2.0	2.7	3.3	3.9	4.6	
single long carriage [A] w/ cover option (kg)	0.50	0.63	0.77	1.07	1.30	1.53	1.76	1.8	2.1	2.8	3.5	4.2	4.9	
dual long carriage [B] w/ cover option (kg)	0.61	0.74	0.88	1.31	1.54	1.78	2.01	-	-	3.2	3.9	4.6	5.3	
single short carriage [C] w/ cover option [-H] (kg)	-	-	-	-	-	-	-	1.6	2.0	2.6	3.3	4.0	4.7	
dual short carriage [D] w/ cover option [-H] (kg)	-	-	-	-	-	-	-	1.9	2.2	2.9	3.5	4.2	4.9	
<b>BALL SCREW DIAMETER (mm)</b>	6			8				10						
<b>DUTY CYCLE (%)</b>														
								100						
<b>BALLSCREW EFFICIENCY (%)</b>														
								90						
<b>MAX BREAKAWAY TORQUE</b>														
commercial grade (oz-in)	0.7			2.1				9.9						
precision grade [P] (oz-in)	1.7			5.7				21.2						
<b>MAX RUNNING TORQUE</b>														
commercial grade (N-m)	X	X	X	X	X	X	X	X	X	X	X	X	X	
precision grade [P] (N-m)	X	X	X	X	X	X	X	X	X	X	X	X	X	
<b>BALLSCREW LEADS AVAILABLE (mm)</b>	1, 5			2, 5				5, 10						
<b>BACKLASH</b>														
commercial grade (microns)	10			10				10						
precision grade [P] (microns)	3			3				3						
<b>MAX BALLSCREW SPEED (rev/sec)</b>	187			140				110		93		62		

[ ] Indicates option code

Sold & Serviced By:

 **ELECTROMATE**

Toll Free Phone (877) SERV098

Toll Free Fax (877) SERV099

www.electromate.com

sales@electromate.com

## SPECIFICATIONS

	URS46							URS55			
RAIL LENGTH (mm)	340	440	540	640	740	840	940	980	1080	1180	1280
<b>HEIGHT (base to carriage top)</b>											
without cover option (mm)	46							55			
without cover option [-H] (mm)	68							80			
<b>BASE WIDTH (mm)</b>	86							100			
<b>MAX TRAVEL (hardstop to hardstop)</b>											
single long carriage [A] (mm)	209	309	409	509	609	709	809	834	934	1034	1134
dual long carriage [B] (mm)	100	200	300	400	500	600	700	711	811	911	1011
single short carriage [C] (mm)	245	345	445	545	645	745	845	-	-	-	-
dual short carriage [D] (mm)	172	272	372	472	572	672	772	-	-	-	-
<b>ACCURACY</b>											
commercial grade (microns)	35		40		50		90		80		100
precision grade [P] (microns)	20		25		30		-		35		40
<b>FLATNESS OF TRAVEL</b>											
commercial grade (microns)	35			40		50		50			
precision grade [P] (microns)	15			20		-		25		30	
<b>REPEATABILITY</b>											
commercial grade (microns)	±5							±5			
precision grade [P] (microns)	±3							±5			
<b>PITCH &amp; YAW</b>											
commercial grade (microns)	x	x	x	x	x	x	x	x	x	x	x
precision grade [P] (microns)	x	x	x	x	x	x	x	x	x	x	x
<b>LOAD CAPACITY, NORMAL (kg)</b>	x	x	x	x	x	x	x	x	x	x	x
<b>AXIAL LOAD CAPACITY (kg)</b>	x	x	x	x	x	x	x	x	x	x	x
<b>ACCELERATION, MAX (m/sec<sup>2</sup>)</b>	x	x	x	x	x	x	x	x	x	x	x
<b>MOVING MASS</b>											
long carriage [A,B] w/o cover option (kg)	0.9							1.7			
long carriage [A,B] w/ cover option [-H] (kg)	1.2							2.3			
short carriage [C,D] w/o cover option (kg)	0.5							-			
short carriage [C,D] w/ cover option [-H] (kg)	0.7							-			
<b>TOTAL MASS</b>											
single long carriage [A] w/o cover option (kg)	6.5	8.0	9.0	10.5	12.0	13.0	14.5	20	22	23	25
dual long carriage [B] w/o cover option (kg)	7.5	8.5	10.0	11.5	13.0	14.0	15.5	22	24	25	27
single short carriage [C] w/o cover option (kg)	6.0	7.5	8.5	10.0	11.5	13.0	14.0	-	-	-	-
dual short carriage [D] w/o cover option (kg)	6.5	8.0	9.5	10.5	12.0	13.5	14.5	-	-	-	-
single long carriage [A] w/ cover option (kg)	7.0	8.5	10.0	11.0	12.5	14.0	15.5	21	23	25	27
dual long carriage [B] w/ cover option (kg)	8.0	9.5	11.0	12.5	14.0	15.5	16.5	24	26	27	29
single short carriage [C] w/ cover option [-H] (kg)	6.5	8.0	9.5	10.5	12.0	13.5	15.0	-	-	-	-
dual short carriage [D] w/ cover option [-H] (kg)	7.0	8.5	10.0	11.5	13.0	14.0	15.5	-	-	-	-
<b>BALL SCREW DIAMETER (mm)</b>	15							20			
<b>DUTY CYCLE (%)</b>	100							100			
<b>BALLSCREW EFFICIENCY (%)</b>	90							90			
<b>MAX BREAKAWAY TORQUE</b>											
commercial grade (oz-in)	14.2							17.0			
precision grade [P] (oz-in)	21.2		24.0		-		24.0		28.3		-
<b>MAX RUNNING TORQUE</b>											
commercial grade (N-m)											
precision grade [P] (N-m)											
<b>BALLSCREW LEADS AVAILABLE (mm)</b>	10, 20							20			
<b>BACKLASH</b>											
commercial grade (microns)	10							50			
precision grade [P] (microns)	3							3			
<b>MAX BALLSCREW SPEED (rev/sec)</b>	74			65		50		39		56	
	45		37		31						

All performance specifications are based upon proper mounting procedures, with the URS fully supported on a flat surface (flat within v0.008mm/300mm).

Above specifications are measured 37.5mm directly above the center of the carriage.

Specifications are based upon operation at 20° C. Contact IDC to discuss your low- and high-temperature applications.

URS positioning tables are rated for normal loads (load vector directed down onto the surface of the carriage), for axial loads (load vector directed in the direction of travel), and for moment loads (torsional loads caused by loads with an offset center of gravity). The moment loading limits are based on the maximum moment in pitch, roll or yaw including any dynamic components that are more profile dependent. Visit [www.DanaherMotion.com/urs](http://www.DanaherMotion.com/urs) to use our moment loading calculator.

\*The specifications in this publication are believed to be accurate and reliable. However, it is the responsibility of the product user to determine the suitability of IDC products for a specific application. Specifications are subject to change without notice.

Sold & Serviced By:

 ELECTROMATE

Toll Free Phone (877) SERV098

Toll Free Fax (877) SERV099

[www.electromate.com](http://www.electromate.com)

[sales@electromate.com](mailto:sales@electromate.com)

# URS20 DIMENSIONAL DRAWING

## Without Cover Option

Note: Optional second carriage shaded gray.

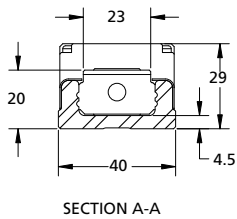
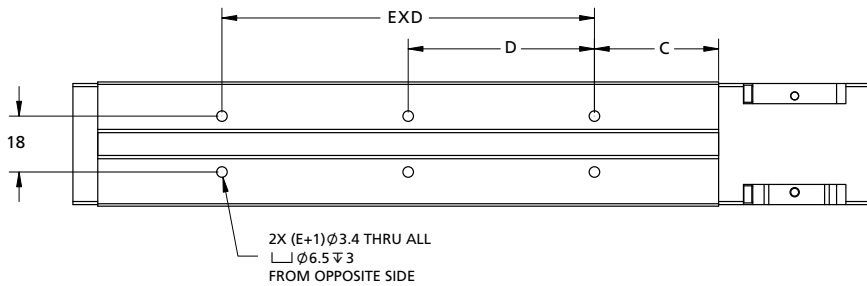
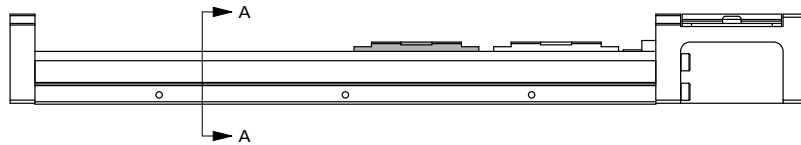
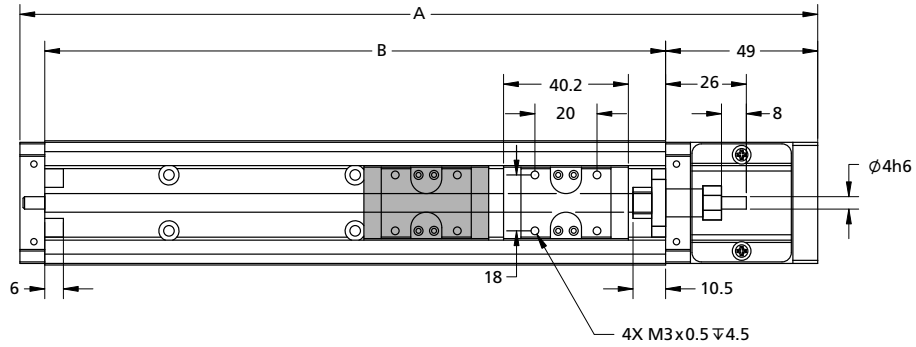
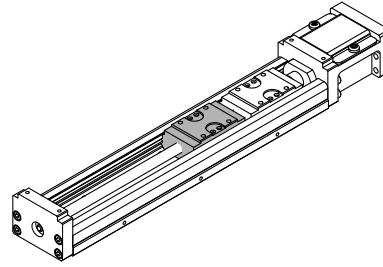

M3x0.5 <math>\nabla 6</math>  
ON A 29MM B.C.

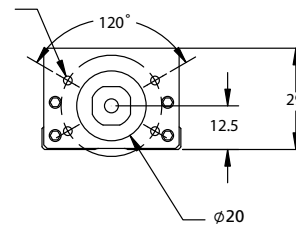



# URS20 DIMENSIONAL DRAWING

## With Cover Option

Note: Optional second carriage shaded gray.

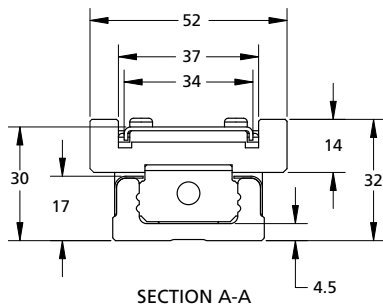
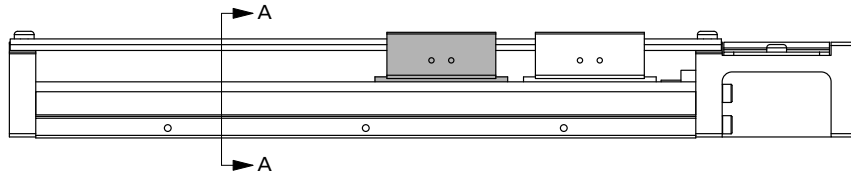
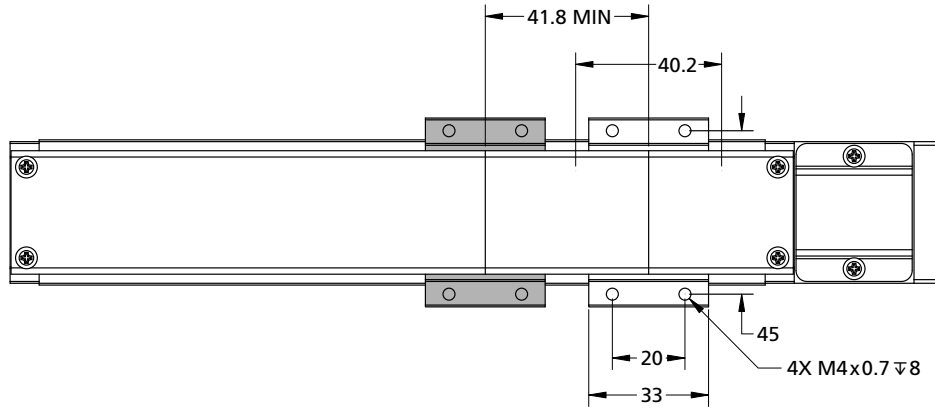
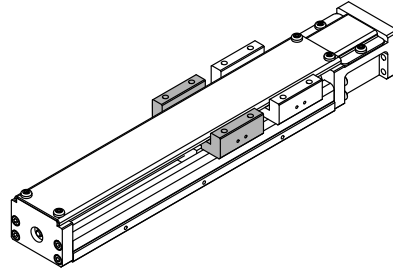

Dimensions					Stroke Limit	
A	B	C	D	E	URS20**A	URS20**B
100	157	20	60	1	43	-
150	207	15		2	93	50
200	257	40		143	100	

# URS26 DIMENSIONAL DRAWING

Without Cover Option

Note: Optional second carriage shaded gray.

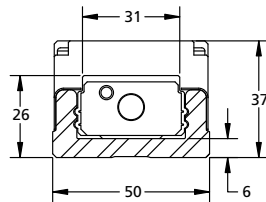
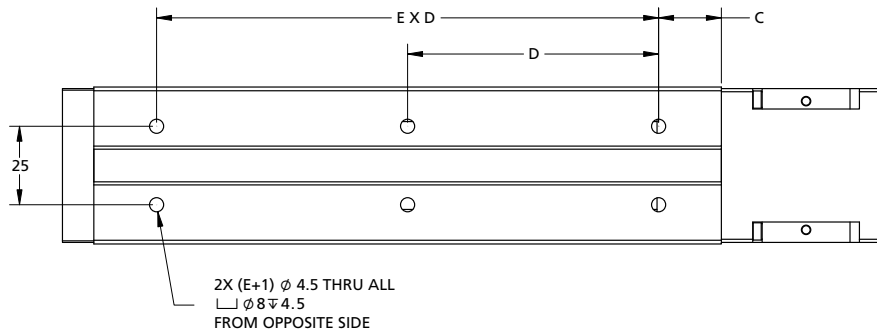
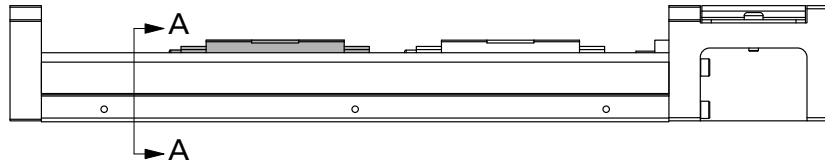
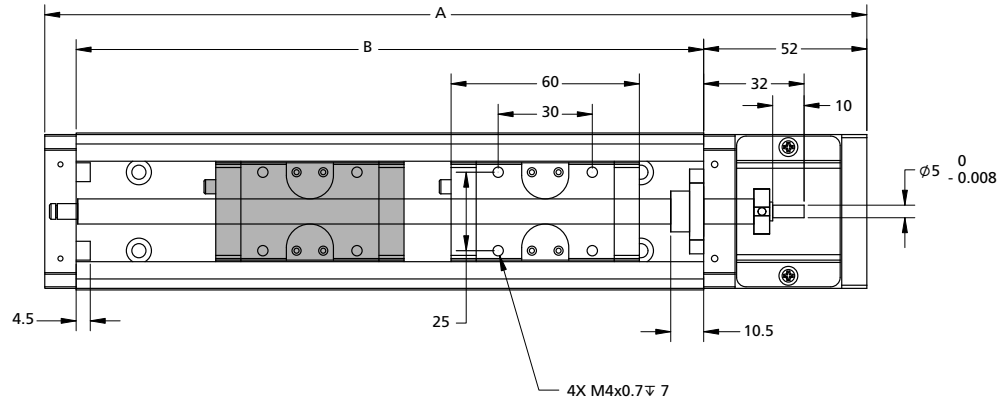
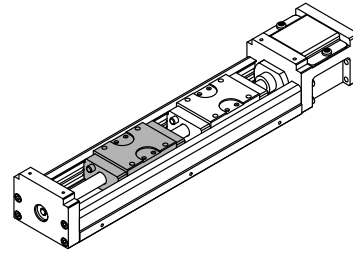

SECTION A-A

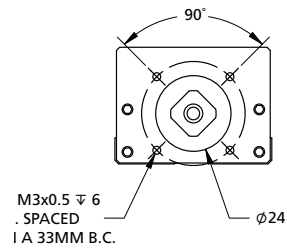

# URS26 DIMENSIONAL DRAWING

## With Cover Option

Note: Optional second carriage shaded gray.

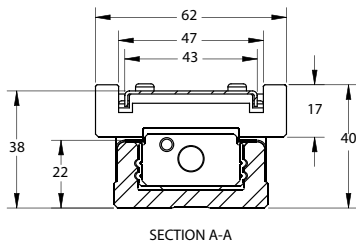
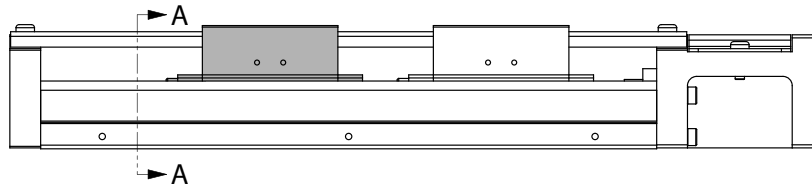
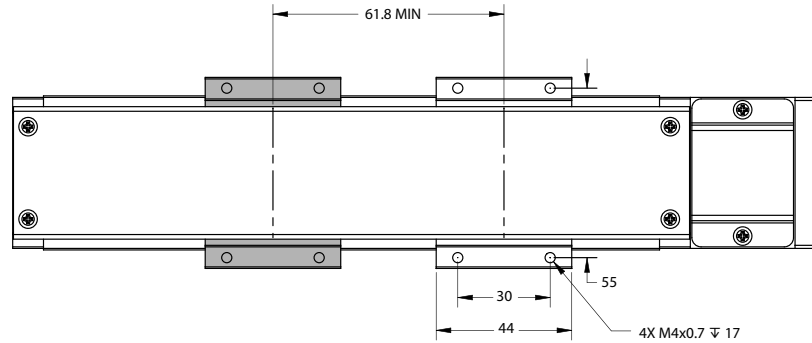
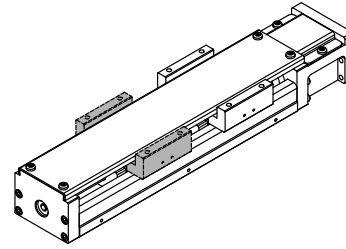

Dimensions					Stroke Limit	
A	B	C	D	E	URS26A	URS26B
150	212	35	80	1	73	-
200	262	20		2	127	61
250	315	45		3	173	111
300	362	30			223	161

# URS33 DIMENSIONAL DRAWING

## Long Carriage(s) Without Cover Option

Note: Optional second carriage shaded gray.

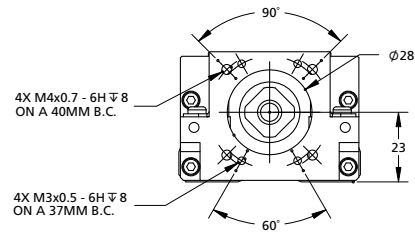
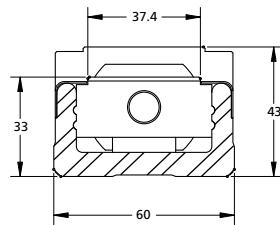
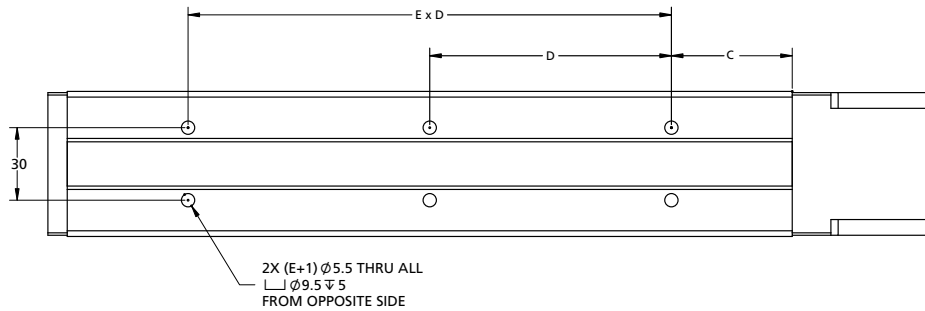
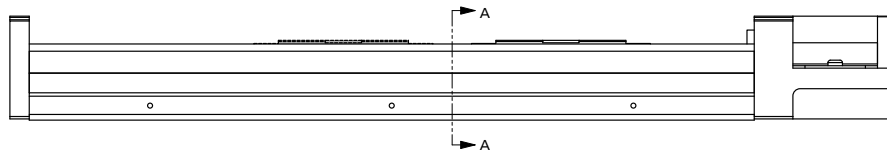
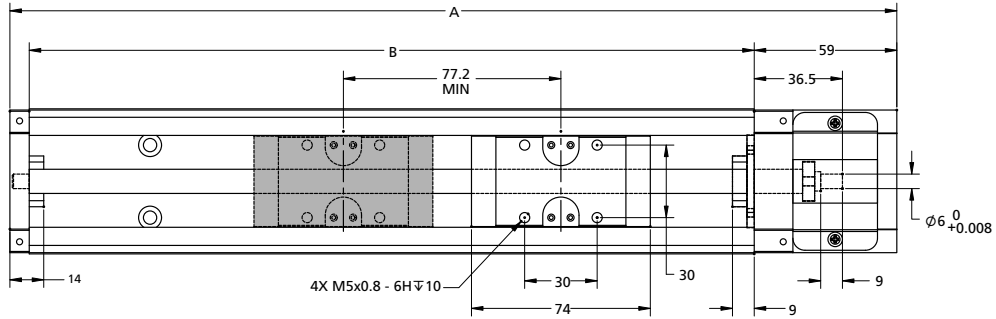
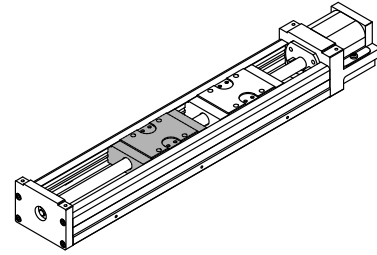

# URS33 DIMENSIONAL DRAWING

## Long Carriages(s) With Cover Option

Note: Optional second carriage shaded gray.

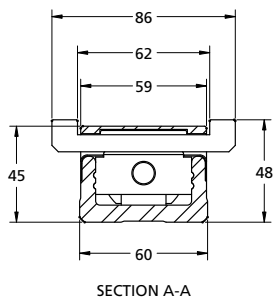
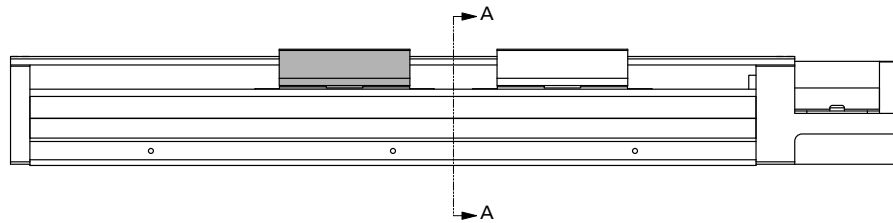
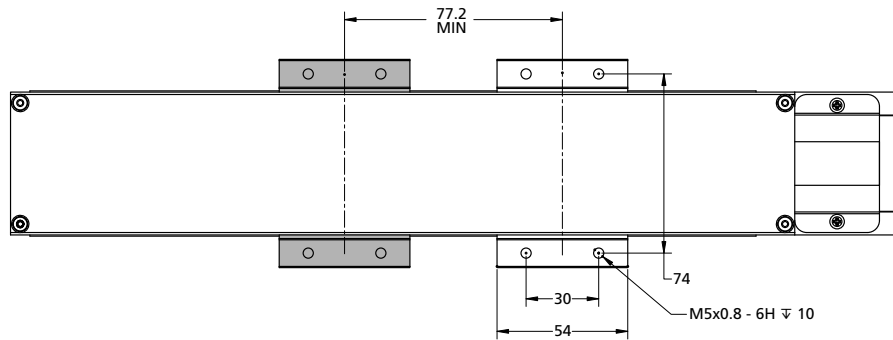
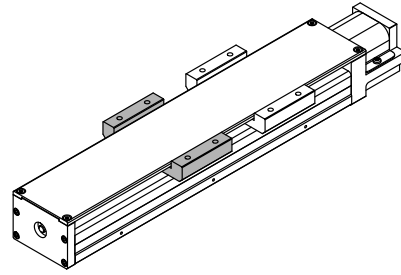

Dimensions					Stroke Limit	
A	B	C	D	E	URS33**A	URS33**B
217	150	25	100	1	60	-
267	200	50		2	110	-
367	300			3	210	133
467	400			4	310	233
567	500			5	410	333
667	600				510	433

# URS33 DIMENSIONAL DRAWING

## Short Carriage(s) Without Cover Option

Note: Optional second carriage shaded gray.

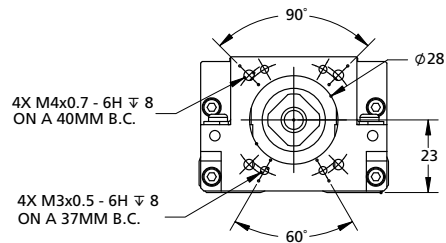
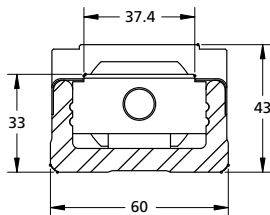
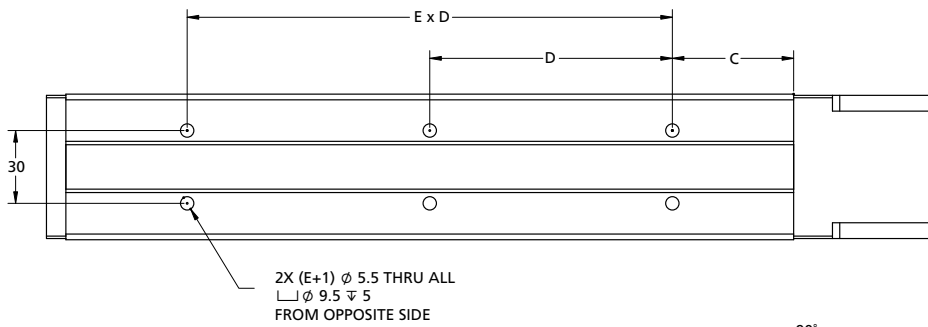
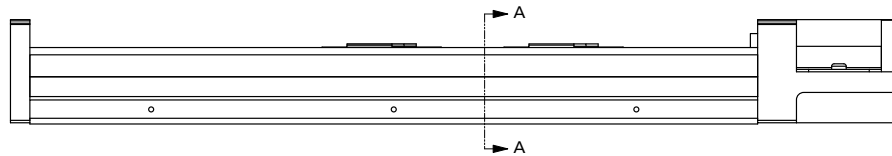
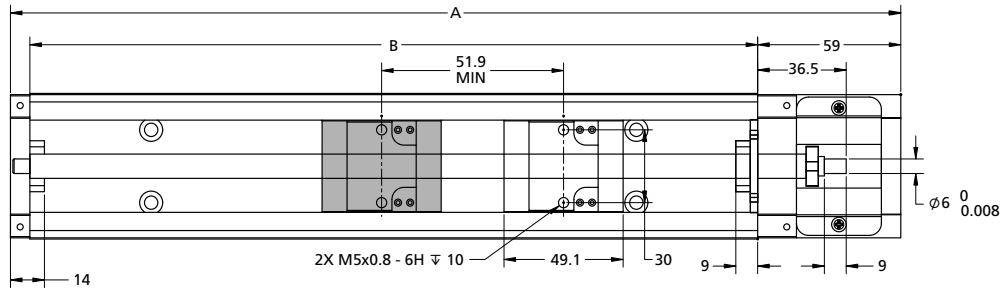
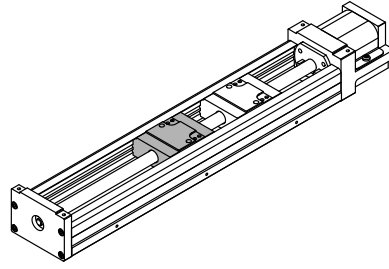

# URS33 DIMENSIONAL DRAWING

## Short Carriage(s) With Cover Option

Note: Optional second carriage shaded gray.

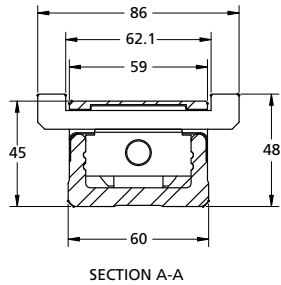
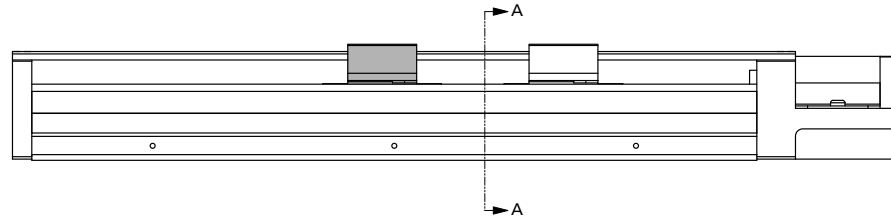
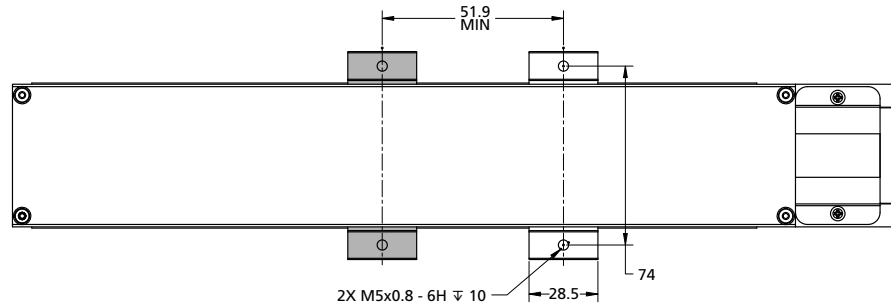
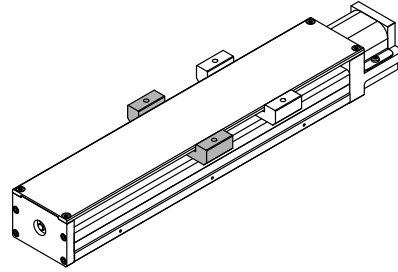

Dimensions					Stroke Limit	
A	B	C	D	E	URS33**C	URS33**D
217	150	25	100	1	85	34
267	200	50			135	84
367	300			2	235	184
467	400			3	335	284
567	500			4	435	384
667	600			5	535	484

# URS46 DIMENSIONAL DRAWING

## Long Carriage(s) Without Cover Option

Note: Optional second carriage shaded gray.

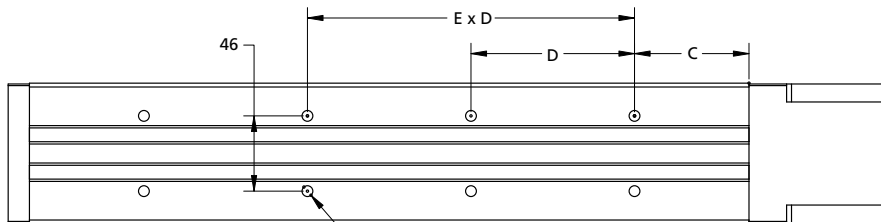
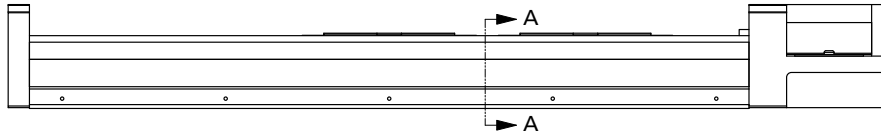
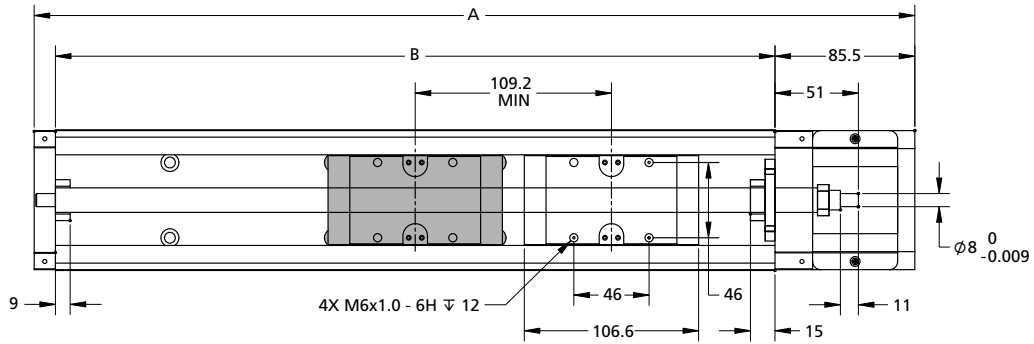
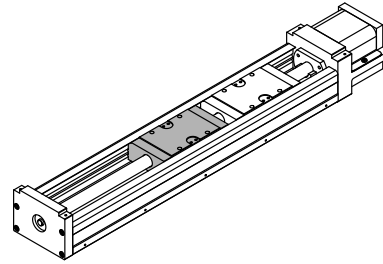

2X (E+1)  $\varnothing$  6.6 THRU ALL  
 $\nabla$   $\varnothing$  11  $\nabla$  6.5  
 FROM OPPOSITE SIDE

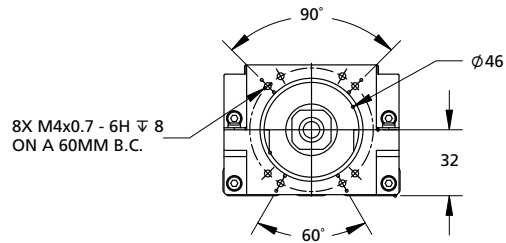
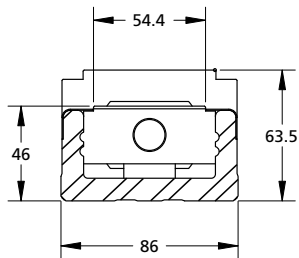



# URS46 DIMENSIONAL DRAWING

## Long Carriage(s) With Cover Option

Note: Optional second carriage shaded gray.

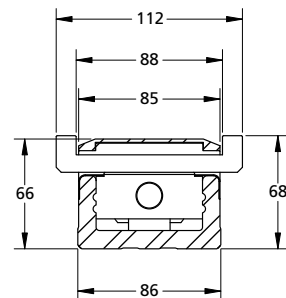
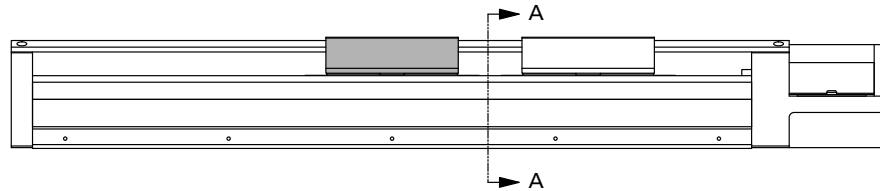
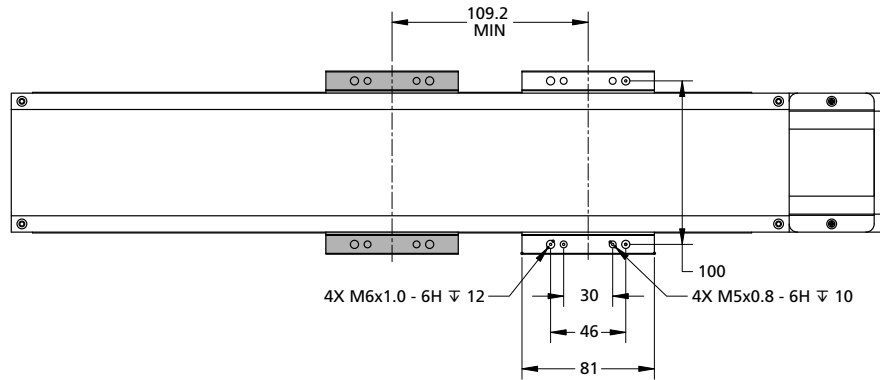
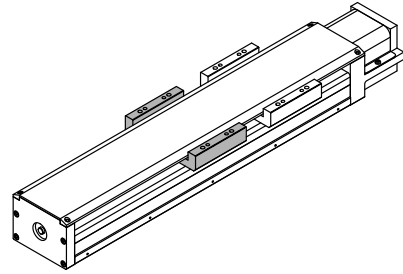

Dimensions					Stroke Limit	
A	B	C	D	E	URS46**A	URS46**B
438.5	340	70	100	2	309	100
538.5	440			3	309	200
638.5	540			4	409	300
738.5	640			5	509	400
838.5	740			6	609	500
938.5	840			7	709	600
1038.5	940			8	809	700

# URS46 DIMENSIONAL DRAWING

## Short Carriage(s) Without Cover Option

Note: Optional second carriage shaded gray.

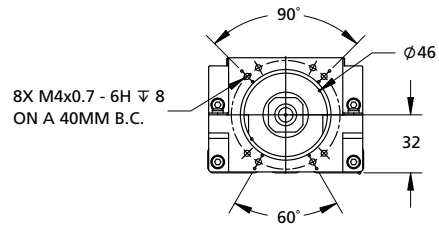
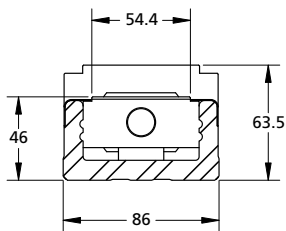
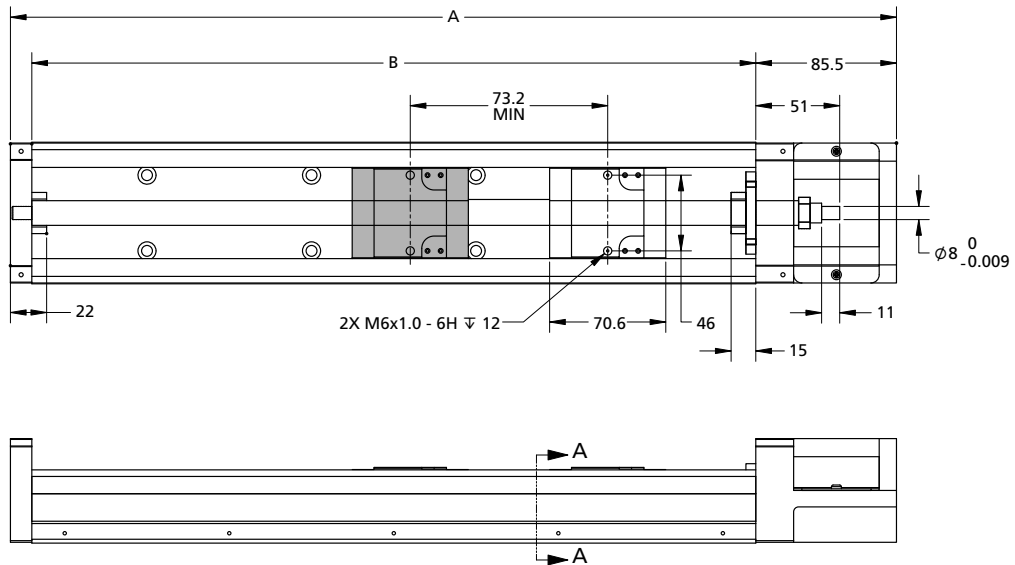
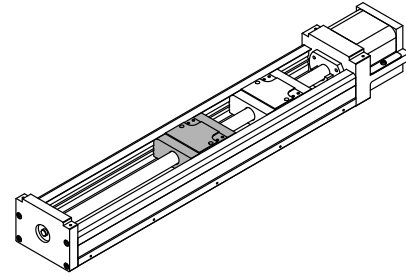

# URS46 DIMENSIONAL DRAWING

## Short Carriage(s) With Cover Option

Note: Optional second carriage shaded gray.

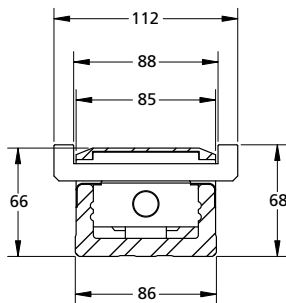
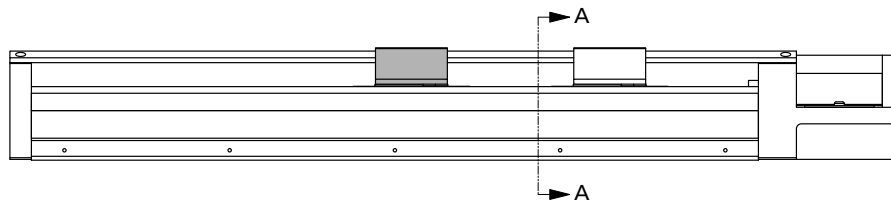
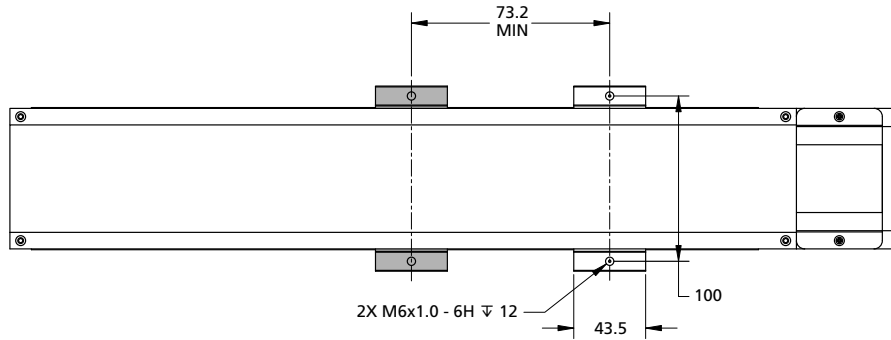
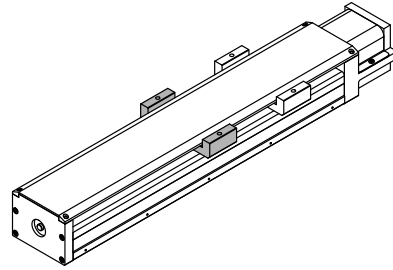

Dimensions					Stroke Limit	
A	B	C	D	E	URS46**C	URS46**D
438.5	340	70	100	2	245	172
538.5	440			3	345	272
638.5	540			4	445	372
738.5	640			5	545	472
838.5	740			6	645	572
938.5	840			7	745	672
1038.5	940			8	845	772

# URS55 DIMENSIONAL DRAWING

## Without Cover Option

Note: Optional second carriage shaded gray.

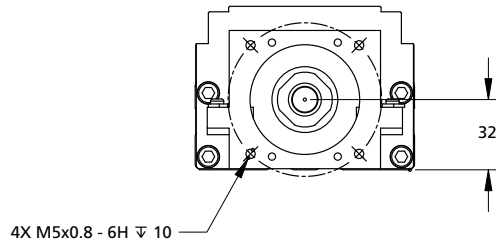
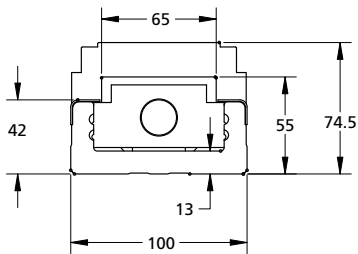
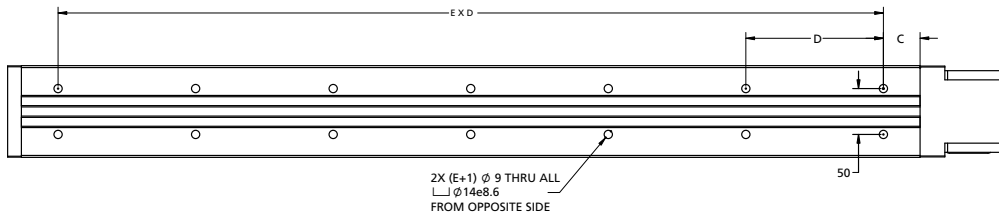
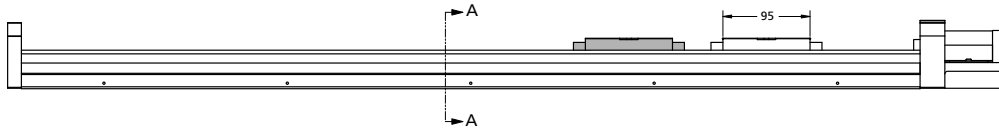
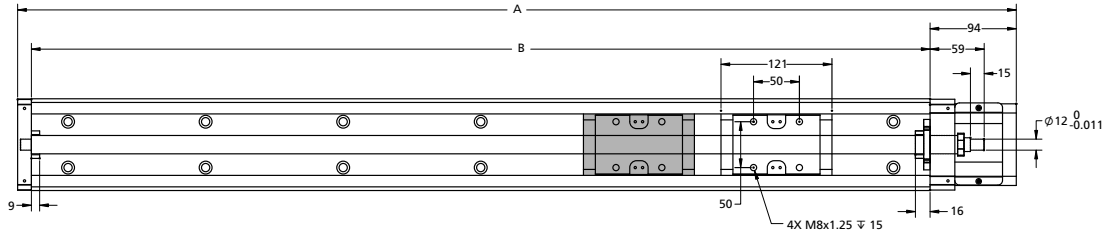
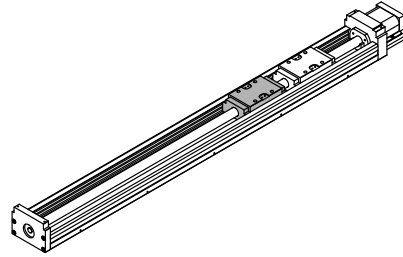

# URS55 DIMENSIONAL DRAWING

## With Cover Option

Note: Optional second carriage shaded gray.

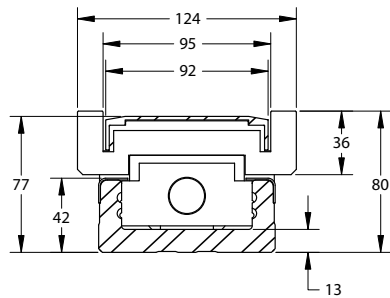
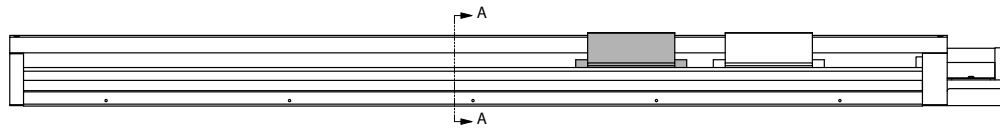
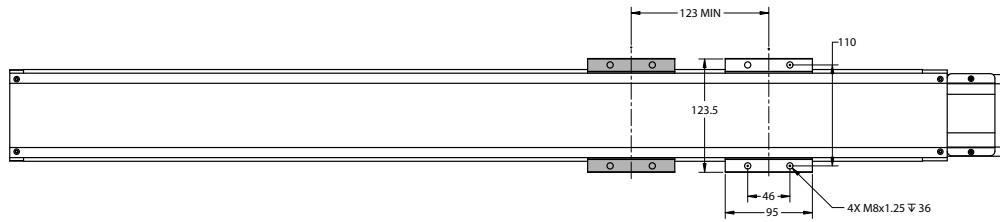
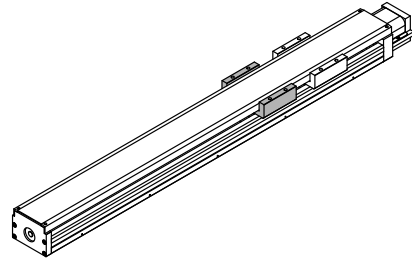

Dimensions					Stroke Limit	
A	B	C	D	E	URS55**A	URS55**B
980	1089	40	150	6	834	711
1080	1189	15		7	934	811
1180	1289	65		8	1034	911
1280	1389	40		9	1134	1011
1380	1489	15			1234	1111

# MOTOR FLANGE OPTIONS

## SELECTION CHART

	X16	X17	X23	X34
Motor Flange Ref (1)	NEMA 16	NEMA 17	NEMA 23	NEMA 34
Encoder Resolution	-	-	-	-
Motor Brake Description	-	-	-	-
URS20	■	■		
URS26	■	■		
URS33	■	■	■	
URS46			■	
URS55			■	■

(1) Flange/motor dimensions may not be "true" NEMA; Reference drawings provided in this brochure.

## X16 Flanges

### URS20

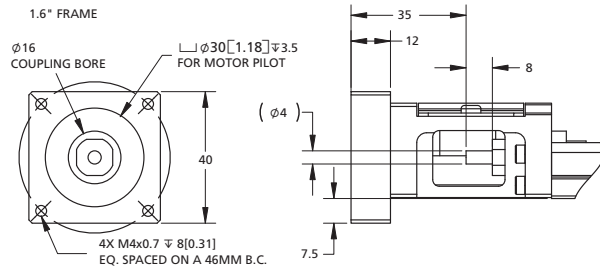

### URS26

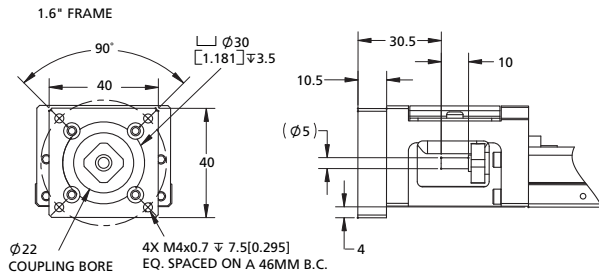

### URS33

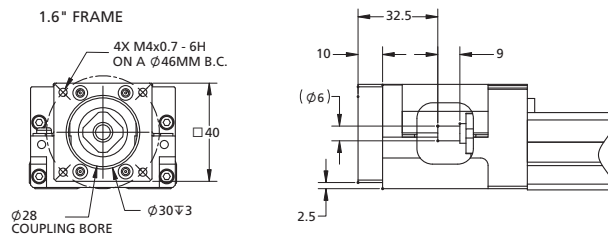

## X17 Flanges

### URS20

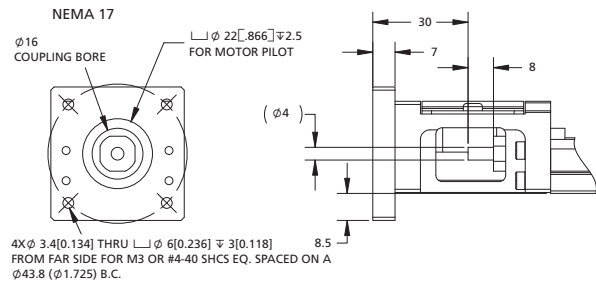

### URS26

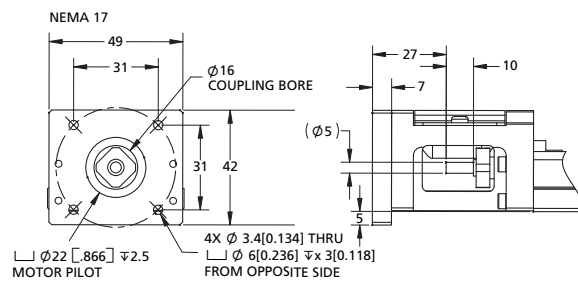

### URS33

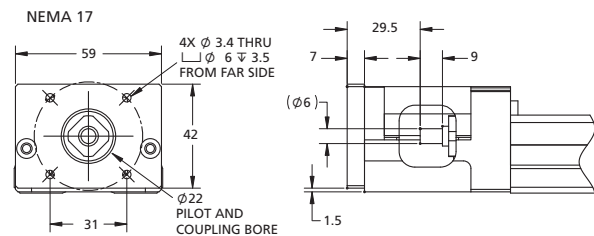

## X23 Flanges

### URS33

NEMA 23

4X M4x0.7 - 6H  
ON A  $\phi 66.7$ MM (2.625IN) B.C.

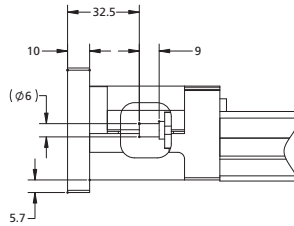
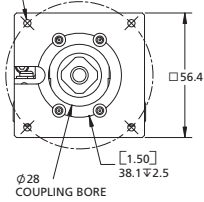

## X34 Flanges

### URS55

NEMA 34

$\phi 50$   
COUPLING BORE  
4X M5x0.8-6H  $\nabla 10$   
EQ. SPACED ON A  
 $\phi 98.4$  [3.875] B.C.

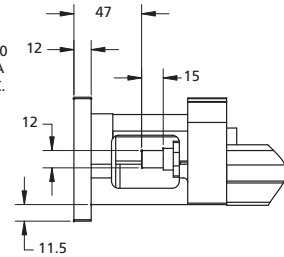
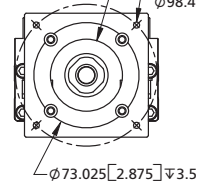

### URS46

NEMA 23

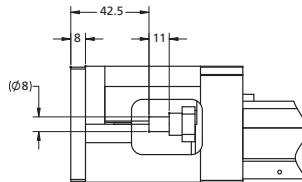
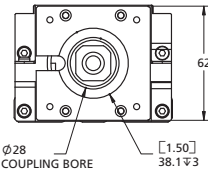

### URS55

NEMA 23

$\phi 28$   
COUPLING BORE  
4X M4x0.76H  $\nabla 8$   
EQ. SPACED ON A  
 $\phi 66.7$  [2.65] B.C.

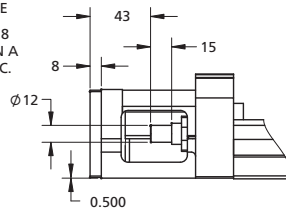
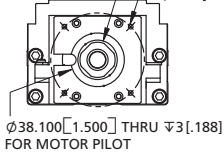

**MODELS ON DEMAND:** Leading edge system for configuring and downloading 3D solid models and 2D drawings.

- Configure a URS to specific requirements including rail length, motor mounting, cover and limit options.
- Rule-based system prevents misconfiguring a model.
- Currently offers fifty-two downloadable CAD formats (3D/2D).
- View 3D model online with zoom, pan and rotate features.
- Real-time downloads (no large emails or FTP sites).

[www.DanaherMotion.com/URS](http://www.DanaherMotion.com/URS)

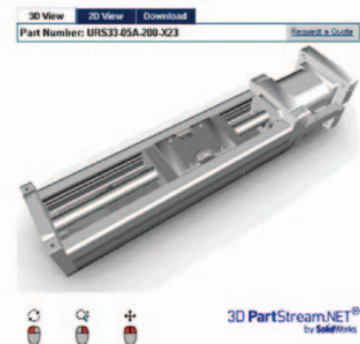
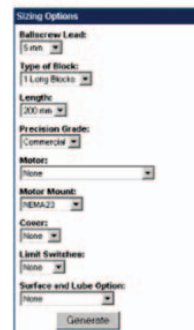

# STEPPER MOTOR OPTIONS

## SELECTION CHART

	T12	T12E	T22	T22E	T32	T32E
Motor Flange Reference	NEMA 17	NEMA 17	NEMA 23	NEMA 23	NEMA 34	NEMA 34
Encoder Resolution	-	1000 lines	-	1000 lines	-	1000 lines
Motor Brake Description	-	-	-	-	-	-
URS20	■	■				
URS26	■	■				
URS33	■	■	■	■		
URS46			■	■		
URS55			■	■	■	■

T12

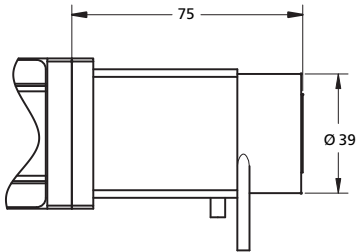

T12E

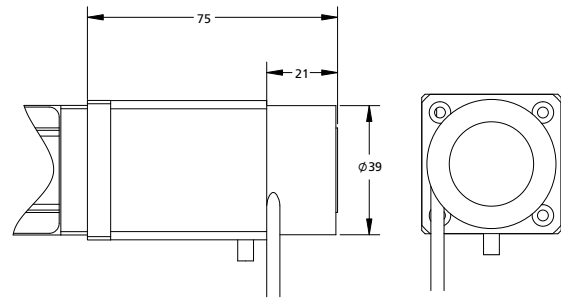

T22

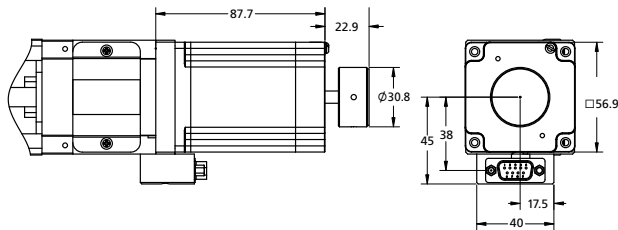

T22E

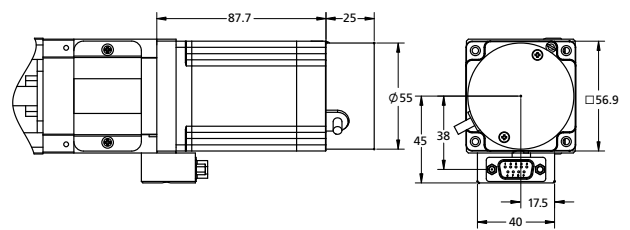



## STEPPER MOTOR PARAMETERS

Specification	Units	T12	T22T	T22V	T32
Holding Torque	N-m (oz-in)	0.32 (45)	1.52 (215)	1.52 (215)	8.5 (1206)
Rated Cont. Current/Phase	A	1.2	0.77	0.77	1.58
Phase Inductance (+/- 20%)	mH/phase	2.8	65.5	17	69.2
Weight	kg (lb)	0.35 (0.8)	1.0 (2.3)	1.0 (2.3)	3.81 (8.4)
Rotor Inertia	kg-cm <sup>2</sup> (lb-in-s <sup>2</sup> )	0.068 (6.02 x 10 <sup>-5</sup> )	0.408 (3.5 x 10 <sup>-4</sup> )	0.408 (3.5 x 10 <sup>-4</sup> )	.038 (0.268 x 10 <sup>-3</sup> )

### T32/T32E

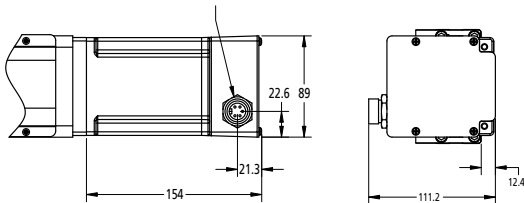

## SERVO MOTOR OPTIONS

### SELECTION CHART

	BK11	BK23	BK23B	BK32	BK32B
Motor Flange Reference	NEMA 16	NEMA 23	NEMA 23	NEM A 34	NEMA 34
Encoder Resolution	2048 lines	2048 lines	2048 lines	2048 lines	2048 lines
Motor Brake Description	-	-	24 VDC Power-off	-	24 VDC Power-off
URS20	■				
URS26	■				
URS33	■	■	■		
URS46		■	■		
URS55		■	■	■	■

### BK11

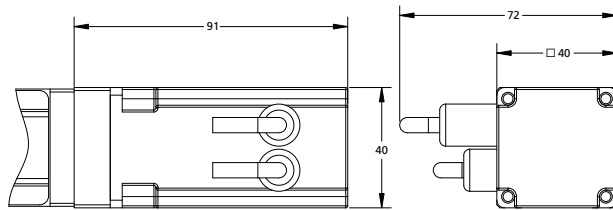

### BK23

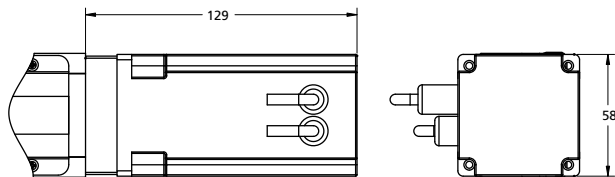

### BK23B

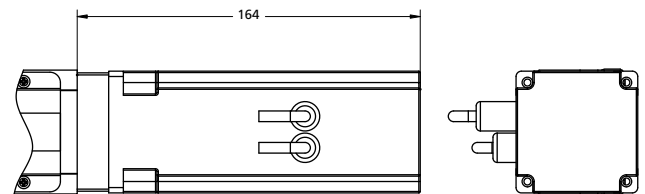

## SERVO MOTOR PARAMETERS

Specification	Units	BK11	BK23	BK23B	BK32	BK32B
Continuous Stall Torque	N-m (oz-in)	0.185 (26)	0.84 (119)	0.83 (117)	3.43 (486)	3.17 (449)
Peak Torque	N-m (oz-in)	0.614 (87)	2.73 (386)	2.73 (386)	11.5 (1629)	11.5 (1629)
Torque Sensitivity +/-10%	N-m/Arms (oz-in/Arms)	0.129 (18.24)	0.61 (86.4)	0.61 (86.4)	0.74 (104)	0.74 (104)
Back EMF +/- 10%	Vrms/krpm	8.3	39	39	47.5	47.5
Maximum Speed	rpm	6000	8000	8000	6000	6000
Weight	kg (lb)	0.35 (0.8)	1.1 (2.4)	1.1 (2.4)	3.39 (7.5)	3.39 (7.5)
Rotor Inertia	kg-cm <sup>2</sup> (lb-in-s <sup>2</sup> )	0.017 (1.5 x 10 <sup>-3</sup> )	0.16 (1.4 x 10 <sup>-4</sup> )	0.17 (1.5 x 10 <sup>-4</sup> )	1.5 (1.3 x 10 <sup>-3</sup> )	1.57 (1.31 x 10 <sup>-3</sup> )

### BK42

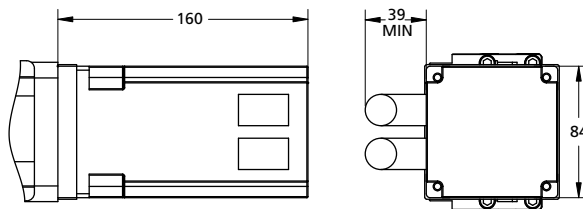

### BK42B

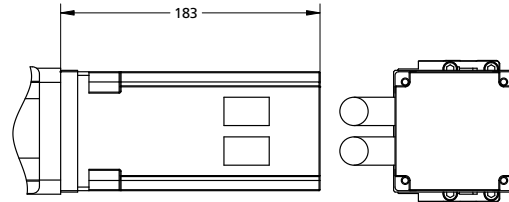

#### CLEANROOM LUBRICATION OPTION

The "GK" lubrication option is a low-particulate generating lubricant suitable for cleanroom applications, with the same lubrication and rust-preventing performance as the standard lithium-based grease. Operating range is -30oC to 150 oC.

#### RAYDENT SURFACE TREATMENT OPTION

The "RD" option provides for Raydent treatment of the rail surfaces. Raydent is a proven, precisely applied thin rust-preventing film. The surface treatment has exceptional durability (greater than 10 years), and any fine grains of Raydent that do break away from the contact between the rail and recirculating ball will actually add to the lubricity of the grease.

## SENSOR OPTIONS

All URS models are offered with optional Limit and home Sensor packages. Sensors are recommended to prevent overtravel of the carriage and to provide a reliable index position. Each sensor package includes a T-slotted mounting rail and three (3) sensors. The Sensors are adjustable throughout the full travel range of the URS.

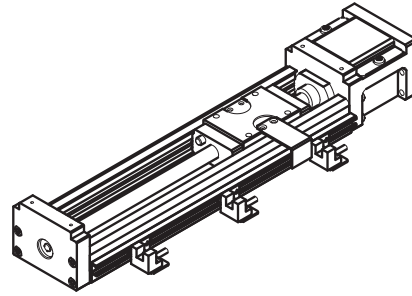

Sensor Type	Photoelectric
Output Logic Type	NPN (sinking)
Switch Type	Normally Open
Input Voltage	5 - 24 VDC +/-10%
Current Capacity	100mA
Repeatability	+/-15 microns

### URS20

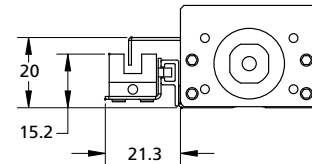
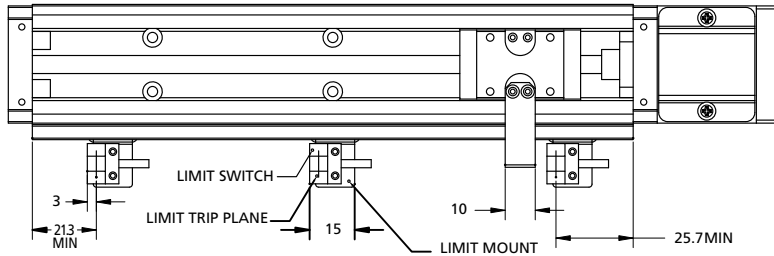

### URS26

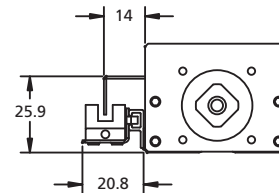
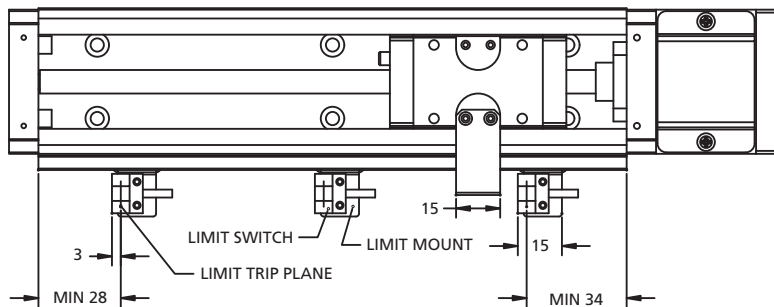

### URS33

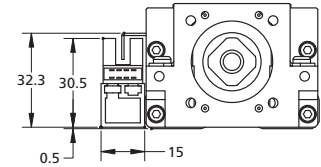
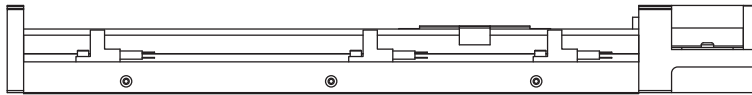
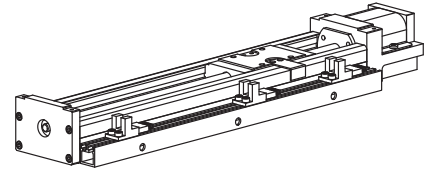
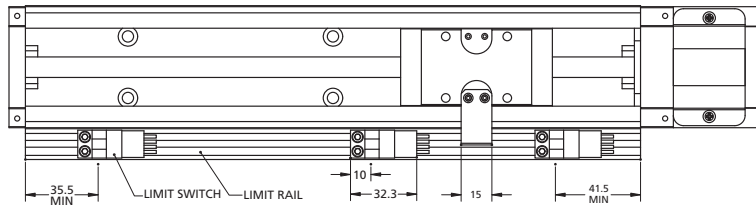

### URS46

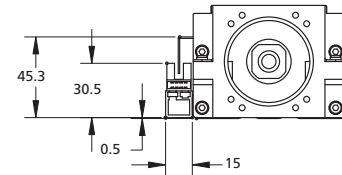
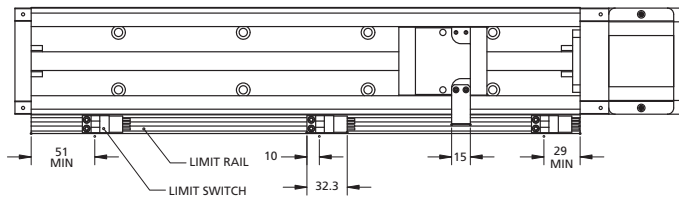
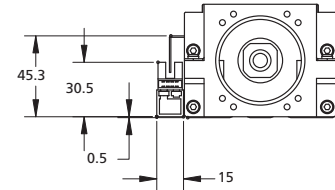
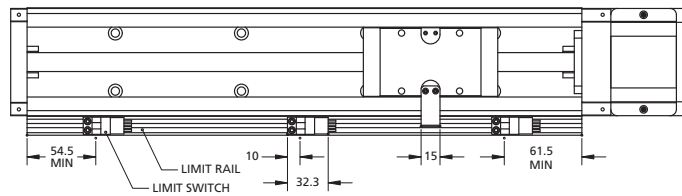

### URS55

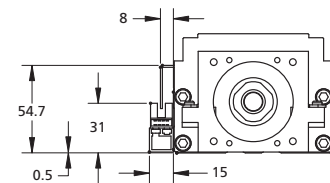
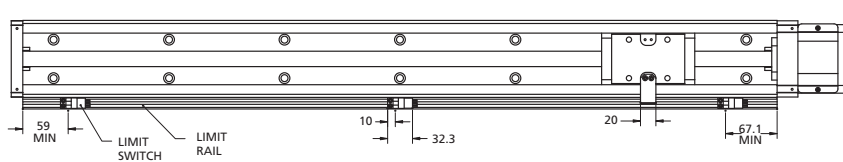

## INERTIA OF THE CARRIAGES(S) AND BALLSCREW

base model	rail length (mm)	without top-cover				with top-cover				rail Length mm
		Long carriage (s)		Short Carriage(s)		Long carriage (s)		Short Carriage(s)		
		single [A]	dual [B]	single [C]	dual [D]	single [A]	dual [B]	single [C]	dual [D]	
URS2001	100	1.36	—	—	—	0.017	—	—	—	100
	150	0.020	—	—	—	0.021	—	—	—	150
	200	0.028	0.030	—	—	0.029	0.031	—	—	200
URS2602	150	0.036	0.038	—	—	0.036	0.039	—	—	150
	200	0.043	—	—	—	0.044	0.046	—	—	200
	250	0.022	0.030	—	—	0.025	0.035	—	—	250
	300	0.026	0.034	—	—	0.029	0.039	—	—	300
URS3305	150	0.016	—	0.016	0.016	0.017	—	—	—	150
	200	0.020	—	0.019	0.020	0.021	—	0.020	0.021	200
	300	0.028	0.030	0.027	0.028	0.029	0.031	0.027	0.029	300
	400	0.036	0.038	0.035	0.036	0.036	0.039	0.035	0.036	400
	500	0.043	0.045	0.042	0.043	0.044	0.046	0.043	0.044	500
	600	0.022	0.030	0.018	0.022	0.025	0.035	0.020	0.025	600
URS3310	150	0.022	0.030	0.018	0.022	0.025	0.035	0.020	0.025	150
	200	0.026	0.034	0.022	0.026	0.029	0.039	0.023	0.029	200
	300	0.034	0.041	0.030	0.034	0.036	0.046	0.031	0.036	300
	400	0.041	0.049	0.038	0.041	0.044	0.054	0.039	0.044	400
	500	0.049	0.057	0.045	0.049	0.052	0.062	0.046	0.052	500
	600	0.179	0.202	0.169	0.182	0.187	0.217	0.174	0.192	600
URS4620	340	0.179	0.202	0.169	0.182	0.187	0.217	0.174	0.192	340
	440	0.218	0.241	0.208	0.220	0.225	0.256	0.213	0.231	440
	540	0.257	0.279	0.246	0.259	0.264	0.295	0.252	0.269	540
	640	0.295	0.318	0.285	0.298	0.303	0.333	0.290	0.308	640
	740	0.334	0.357	0.324	0.337	0.342	0.372	0.329	0.347	740
	840	0.247	0.339	0.207	0.258	0.278	0.399	0.227	0.298	840
	940	0.286	0.377	0.246	0.296	0.317	0.438	0.266	0.337	940
URS4610	340	0.247	0.339	0.207	0.258	0.278	0.399	0.227	0.298	340
	440	0.286	0.377	0.246	0.296	0.317	0.438	0.266	0.337	440
	540	0.325	0.416	0.284	0.335	0.355	0.477	0.305	0.376	540
	640	0.364	0.455	0.323	0.374	0.394	0.516	0.344	0.414	640
	740	0.403	0.494	0.362	0.413	0.433	0.555	0.382	0.453	740
	840	1.462	1.635	—	—	1.523	1.756	—	—	840
	940	1.585	1.757	—	—	1.646	1.879	—	—	940
URS5520	980	1.462	1.635	—	—	1.523	1.756	—	—	980
	1080	1.585	1.757	—	—	1.646	1.879	—	—	1080
	1180	1.707	1.880	—	—	1.768	2.001	—	—	1180
	1280	1.830	2.002	—	—	1.891	2.124	—	—	1280
	1380	1.953	2.125	—	—	2.013	2.246	—	—	1380

[A], [B], [C], [D] Represents carriage option.

## ACCURACY STANDARDS

### Positioning Repeatability:

Establish an arbitrary point. From one end, position the inner block at this point and measure the stop position. Repeat the positioning and measure the stop position. Repeat the positioning and measurement process 7 times. Repeat the same process with respect to the established set point at the midpoint and near both ends of travel. Take the maximum measurement and divide the maximum difference by 2 and indicate it with either a positive or negative sign as the test result.

$$\text{Positioning Repeatability} = \pm 1/2 \{(\text{Maximum value of } \ell_n) - (\text{Minimum value of } \ell_n)\}$$

### Positioning Accuracy:

Positioning is performed in only one direction and the resulting position is set as the reference measurement point. Calculate the difference between the length of actual travel and the commanded travel length. continuing in the same direction (without returning to the start point) repeat this process randomly several times until reaching limit of full stroke. Express the accuracy by the absolute maximum difference.

$$\text{Positioning Accuracy} = (\Delta \ell)_n \text{max}$$

### Running Parallelism:

Making sure that the surface plate is absolutely flat. Use the test indicator as shown in at the right, run the block over the entire length of travel and use the maximum difference in readings as the test results.

### Backlash:

Use the feed screw to move the block a little. Take the test indicator reading and make it the reference point. While in this position, load the block in the same direction without using the feed screw. Release the load and read the return. Calculate the difference between the reference point. Repeat the same process at the midpoint and near both ends. Use the maximum difference as the test result.

$$\text{Backlash} = (\Delta \ell) \text{max}$$

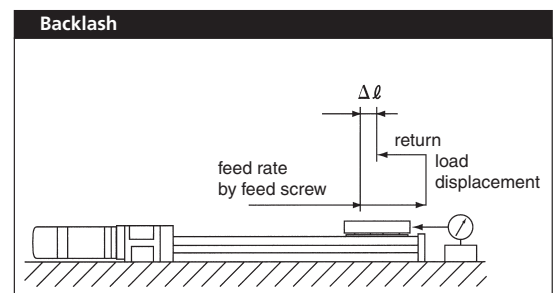
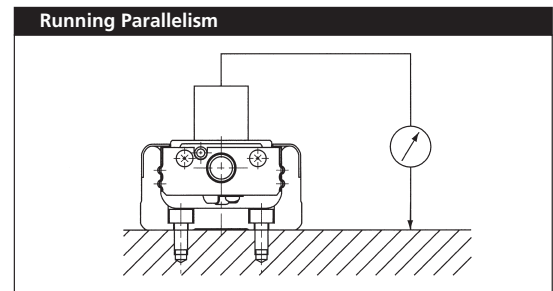
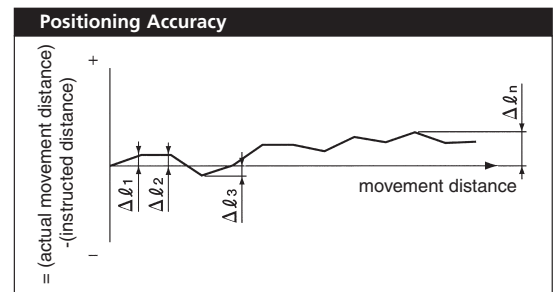
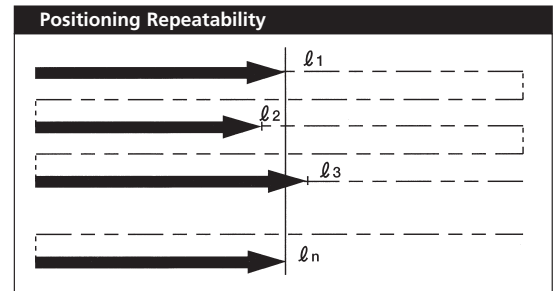

## RATED LIFE

To obtain the rated life of the URS actuator, complete the following life calculation equations for the Guide portion (A) and the Ball Screw / Support Bearing portion (B) and use the minimum value as your rated life.

### A. Life of the Guide

Life of the guide is calculated as follows:

equation (1)

$$L_G = \left( \frac{f_c}{f_w} \cdot \frac{C}{P_T} \right)^3 \cdot 50$$

$L_G$ : Life in distance (Km)  $f_c$ : Contact coefficient (See Table 1)

$f_w$ : Load coefficient (See Table 2)

C: Basic dynamic rating (N)

$P_T$ : Calculated load carried by single block (N)

#### A-1 Calculation of $P_T$

To calculate the life by using equation (1) for  $P_T$ , it is necessary to obtain theoretical load on single carriage by taking the actual moment load and other factors into consideration. When high acceleration or short stroke motion is present,  $P_T$  should be calculated with acceleration in consideration. This calculation for acceleration is performed with the mass carried by the URS actuator.

To obtain  $P_T$ , calculate each load at uniform motion, acceleration motion, and deceleration motion. The average value is  $P_T$ .

**Table 1 Contact coefficient ( $f_c$ )**

number of blocks to be mounted on an axis	contact coefficient ( $f_c$ )
1	1
2	0.81

**Table 2 Load coefficient ( $f_w$ )**

Operating condition		Load coefficient ( $f_w$ )
vibration	speed	
none	5m/min or less	1.0 ~ 1.5
minor	0m/min or less	1.5 ~ 2.0
major	m/min or more	2.0 ~ 3.5

**Table 3 Equivalent coefficient of the moment**

	$k_p$	$k_y$	$k_r$
URS20**A	$2.16 \times 10^{-1}$	$1.82 \times 10^{-1}$	$7.84 \times 10^{-2}$
URS20**B	$3.56 \times 10^{-2}$	$2.99 \times 10^{-2}$	$3.92 \times 10^{-2}$
URS26**A	$1.41 \times 10^{-1}$	$1.18 \times 10^{-1}$	$5.85 \times 10^{-2}$
URS26**B	$2.34 \times 10^{-2}$	$1.96 \times 10^{-2}$	$2.92 \times 10^{-2}$
URS33**A	$1.18 \times 10^{-1}$	$9.90 \times 10^{-2}$	$4.84 \times 10^{-2}$
URS33**B	$1.96 \times 10^{-2}$	$1.65 \times 10^{-2}$	$2.42 \times 10^{-2}$
URS33**C	$2.36 \times 10^{-1}$	$2.02 \times 10^{-1}$	$4.83 \times 10^{-2}$
URS33**D	$3.93 \times 10^{-2}$	$3.37 \times 10^{-2}$	$2.41 \times 10^{-2}$
URS46**A	$7.87 \times 10^{-2}$	$6.61 \times 10^{-2}$	$3.19 \times 10^{-2}$
URS46**B	$1.31 \times 10^{-2}$	$1.10 \times 10^{-2}$	$1.60 \times 10^{-2}$
URS46**C	$1.57 \times 10^{-1}$	$1.33 \times 10^{-1}$	$3.19 \times 10^{-2}$
URS46**D	$2.62 \times 10^{-2}$	$2.22 \times 10^{-2}$	$1.60 \times 10^{-2}$
URS55**A	$6.75 \times 10^{-2}$	$5.69 \times 10^{-2}$	$2.75 \times 10^{-2}$
URS55**B	$1.12 \times 10^{-2}$	$9.48 \times 10^{-3}$	$1.38 \times 10^{-2}$

#### i) At uniform motion ( $P_{TC}$ )

equation (2)

$$P_{TC} = \left( \frac{1}{n} \cdot W \right) + (k_p \cdot Mp) + (k_y \cdot My) + (k_r \cdot Mr)$$

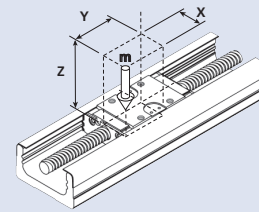

#### ii) At uniform motion ( $P_{Ta}$ )

equation (3)

$$P_{Ta} = \frac{1}{n} \cdot W + k_p (Mp + m \cdot \alpha_a \cdot Z) + k_y (My + m \cdot \alpha_a \cdot X) + k_r \cdot Mr$$

However, when the value of  $(M_p + m \cdot \alpha_a \cdot Z)$ ,  $(M_y + m \cdot \alpha_a \cdot X)$  is negative, mark it zero.

#### iii) At deceleration motion ( $P_{Td}$ )

equation (4)

$$P_{Td} = \frac{1}{n} \cdot W + k_p (Mp + m \cdot -\alpha_d \cdot Z) + k_y (My + m \cdot -\alpha_d \cdot X) + k_r \cdot Mr$$

However, when the value of  $(M_p + m \cdot -\alpha_d \cdot Z)$ ,  $(M_y + m \cdot -\alpha_d \cdot X)$  is negative, mark zero.

$P_{TC}$ : Calculated load carried by single block at uniform motion (N)

$P_{Ta}$ : Calculated load carried by single block at acceleration motion (N)

$P_{Td}$ : Calculated load carried by single block at deceleration motion (N)

$n$ : Number of carriages(s) on URS actuator

$W$ : Load(N)

$M$ : Mass carried by the actuator

$\alpha_a$ : Acceleration (m/sec<sup>2</sup>)

$\alpha_d$ : Deceleration (m/sec<sup>2</sup>)



- X: Distance from the center of URS Actuator to center of gravity of the mass (MM)
- Z: Distance from the center or ball screw in URS actuator to the center of gravity of the mass (mm)
- kp: Equivalent coefficient of the moment at pitching direction (see Table 3)
- ky: Equivalent coefficient of the moment at yawing direction (See Table 3)
- kr: Equivalent coefficient of the moment at rolling direction (See Table 3)
- Mp: Load moment at pitching direction (Nmm)
- My: Load moment at yawing direction (Nmm)
- Mr: Load moment at rolling direction (Nmm)

Using the above factors to calculate average load, obtain the theoretical load carried by single carriage (P<sub>T</sub>).

equation (5)

$$P_T = \sqrt[3]{\frac{1}{(S1+S2+S3)} (P_{Ta}^3 \cdot S1 + P_{Tc}^3 \cdot S2 + P_{Td}^3 \cdot S3)}$$

Figure (1)

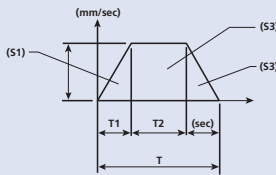

- P<sub>T</sub>: Calculated load carried by single carriage (N)
- S1: Travel distance at acceleration motion (mm) (See Fig. 1)
- S2: Travel distance at uniform motion (mm) (See Fig. 1)
- S3: Travel Distance at decelerating motion (mm) (See Fig. 1)
- P<sub>Ta</sub>: Calculated load carried by single carriage at acceleration motion (N)—Equation (3)
- P<sub>Tc</sub>: Calculated load carried by single carriage at uniform motion (N)—Equation (2)
- P<sub>Td</sub>: Calculated load carried by single carriage at deceleration motion (N)—Equation (4)

**B. Life of the Ball Screw and Support Bearing Calculations**  
 of life for Ball Screw and Support Bearing are performed by common equation as introduced hereunder. Compare the dynamic load rating of Ball Screw and that of Support Bearing and use the lesser value for life calculation.

equation (6)

$$L_a = \left( \frac{1}{f_w} \cdot \frac{C_a \text{ or } C_b}{P_a} \right)^3 \cdot \gamma$$

- L<sub>a</sub>: Life in travel distance (km)
- f<sub>w</sub>: Load coefficient (See Table 2)
- C<sub>a</sub>: Basic Dynamic load rating of ball screw (N)
- C<sub>b</sub>: Basic dynamic load rating of support bearing (N)
- P<sub>a</sub>: Load at axis direction (N)
- γ: Lead of Ball Screw (mm)

**B-1. Calculation of Pa**

To calculate life by using equation (6), perform calculation for Pa with acceleration in consideration. Calculate the load at axis direction for each case at uniform motion, acceleration motion, and deceleration motion. Then obtain the average load of Pa.

**i) At uniform motion (P<sub>ac</sub>)**

equation (7)

$$P_{ac} = \mu \cdot W + F + f_b \cdot n$$

**ii) At acceleration motion (P<sub>aa</sub>)**

equation (8)

$$P_{aa} = \mu \cdot W + F + f_b \cdot n + (m + m_b \cdot n) \alpha_a$$

**iii) At deceleration motion (P<sub>ad</sub>)**

equation (9)

$$P_{ad} = \mu \cdot W + F + f_b \cdot n - (m + m_b \cdot n) \alpha_d$$

- P<sub>ac</sub>: Basic load rating at axis direction at uniform motion (N)
- P<sub>aa</sub>: Basic load rating at axis direction at acceleration motion (N)
- P<sub>ad</sub>: Basic load rating at axis direction at deceleration motion (N)
- μ: Frictional coefficient (0.006)
- W: Load applied on block (N)
- F: External force (load) on axis direction (N)
- f<sub>b</sub>: Sliding resistance of single carriage (N) (See Table 5-2)
- n: Number of carriage(s) on URS actuator
- m: Mass carried by the actuator (Kg)
- m<sub>b</sub>: Mass of the carriage of URS actuator (kg) (See "Moving Mass" specifications on page 4-5)
- α<sub>a</sub>: Acceleration (m/sec<sup>2</sup>)
- α<sub>d</sub>: Deceleration (m/sec<sup>2</sup>)

**Table 4 Sliding resistance of single black (f<sub>b</sub>)**

	(Rolling resistance + Seal resistance)	
	Unit:N	
	Commercial grade	precision grade (P)
URS20	2.3	4.9
URS26	5.4	9.8
URS33	4.4	10.2
URS46	7.4	13.3
URS55	9.0	16.0

Hence, the average axis directional load (P) would be obtained.

equation (10)

$$P_a = \sqrt[3]{\frac{1}{(S1+S2+S3)} (|P_{aa}|^3 \cdot S1 + |P_{ac}|^3 \cdot S2 + |P_{ad}|^3 \cdot S3)}$$

- P<sub>a</sub>: Average axis directional load (N)
- S1: Travel distance at acceleration motion (mm) (See Fig. 1)
- S2: Travel distance at uniform motion (mm) (See Fig. 1)
- S3: Travel distance at deceleration motion (mm) (See Fig. 1)
- P<sub>aa</sub>: Axis direction load at acceleration motion (N) Equation (8)
- P<sub>ac</sub>: Axis direction load at uniform motion (N) - Equation (7)
- P<sub>ad</sub>: Axis directional load at deceleration motion (N) - Equation (9)

## PART NUMBERING/ORDERING INFORMATION

Base Unit	Ballscrew Lead	Carriage Type	Rail Length	Grade	Motor or Motor Flange	Cover Option	Sensor Option	Surface & Lube Options
URS20	01	A	100	P	X17	H	S	GKRD
1	2	3	4	5	6	7	8	9

### URS20 AVAILABLE CONFIGURATIONS

URS20	01 05	A B	100 150 200	(none) P	X16 X17 T12E BK11	(none) H	(none) S	(none) GK GKRD
-------	----------	--------	-------------------	-------------	----------------------------	-------------	-------------	----------------------

### URS26 AVAILABLE CONFIGURATIONS

URS26	02 05	A B	150 200 250 300	(none) P	X16 X17 T12 T12E BK11	(none) H	(none) S	(none) GK RD GKRD
-------	----------	--------	--------------------------	-------------	-----------------------------------	-------------	-------------	----------------------------

### URS33 AVAILABLE CONFIGURATIONS

URS33	05 10	A B C D	150 200 300 400 500 600	(none) P	X16 X17 X23 T12 T12E T22 T22E BK11 BK23 BK23B	(none) H	(none) S	(none) GK RD GKRD
-------	----------	------------------	--	-------------	--	-------------	-------------	----------------------------

### URS46 AVAILABLE CONFIGURATIONS

URS46	10 20	A B C D	340 440 540 640 740 840 940	(none) P	X23 T22 T22E BK23 BK23B	(none) H	(none) S	(none) GK RD GKRD
-------	----------	------------------	---	-------------	-------------------------------------	-------------	-------------	----------------------------

### URS55 AVAILABLE CONFIGURATIONS

URS55	20	A B	980 1080 1180 1280 1380	(none) P	X23 X34 T22 T22E T32 T32E BK23 BK23B BK42 BK42B	(none) H	(none) S	(none) GK RD GKRD
-------	----	--------	-------------------------------------	-------------	--	-------------	-------------	----------------------------

## CONFIGURATION GUIDE

### 1. Base Unit

URS20	Base rail profile = 20mm tall x 40mm wide
URS26	Base rail profile = 26mm tall x 50mm wide
URS33	Base rail profile = 33mm tall x 60mm wide
URS46	Base rail profile = 46mm tall x 86mm wide
URS55	Base rail profile = 55mm tall x 100mm wide

### 2. Ballscrew Lead

01	1mm lead ballscrew
02	2mm lead ballscrew
05	5mm lead ballscrew
10	10mm lead ballscrew
20	20mm lead ballscrew

### 3. Carriage Type

A	Single long (standard) carriage
B	Dual long (standard) carriages
C	Single short carriage
D	Dual short carriages

### 4. Rail Length

Specified in mm.	Refer to Specifications for allowable travel
------------------	--

### 5. Grade

C	Commercial grade
P	Precision grade

### 6. Motor or Motor Flange

X16	Motor flange for 16 Frame motor
X17	Motor flange for 17 Frame motor
X23	Motor flange for 23 Frame motor
X34	Motor flange for 34 Frame motor
T12	Stepper motor, 17 Frame
T12E	Stepper motor, 17 Frame with encoder
T22	Stepper motor, 23 Frame
T22E	Stepper motor, 23 Frame with encoder
T32	Stepper motor, 34 Frame
T32E	Stepper motor, 34 Frame with encoder
BK12	Brushless servo motor, 16 Frame with encoder
BK22	Brushless servo motor, 23 Frame with encoder
BK22B	Brushless servo motor, 23 Frame with encoder & brake
BK32	Brushless servo motor, 34 Frame with encoder
BK32B	Brushless servo motor, 34 Frame with encoder & brake

### 7. Cover Option

(none)	No cover provided
C	Cover provide with auxiliary carriage plate

### 8. Sensor Option

(none)	No cover provided
H	Hard cover provide with auxiliary carriage plate

### 9. Surface Treatment & Lube Options

(none)	No additional options provided
GK	Cleanroom (low-particulate) lubrication
RD	Raydent treatment of rail surfaces
GKRD	GK & RD options (described above)

## LUBRICATION AND OPERATION TEMPERATURE

- The URS contains a lithium-soap based grease. Apply similar grade of grease for lubrication as required depending on your terms of operation.
- Use grease fitting to lubricate the guide block. For ball screw apply grease directly to surface of screw shaft
- Unless otherwise instructed, a grease fitting is located as shown
- The recommended ambient working temperature is 80°C or lower. Apply 55°C or lower for sensor option type.

